

Superroll MAC Selection Chart

Dimensional Drawing (mm)

Hole size $\phi 4.5 - \phi 14.5$

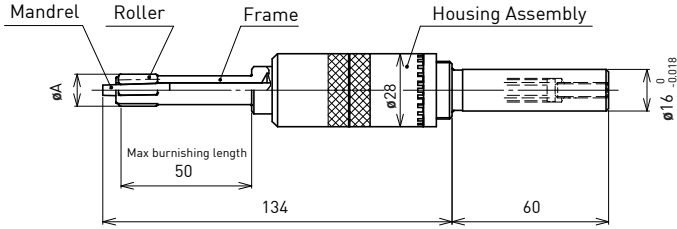

Tool model		Tool diameter adjustment range ΦA		Part No.							
Through-hole	Blind-hole	Min.	Max.	Roller		Q'ty	Mandrel	Frame		Stem	
				Through-hole	Blind-hole			Through-hole	Blind-hole		
SH450-CAT	-	4.45	4.80	R001	-	4	M001	SH450FR	-	-	
SH475-CAT	-	4.70	5.05	R002	-		M002	SH475FR	-	-	
SH500-CAT	-	4.95	5.30				M003	SH500FR	-	-	
SH525-CAT	-	5.20	5.55	R003	-		M002	SH525FR	-	-	
SH550-CAT	-	5.45	5.80				M003	SH550FR	-	-	
SH575-CAT	-	5.70	6.05				M004	SH575FR	-	-	
SH600-CAT	-	5.95	6.45	R004	-		M004	SH600FR	-	-	
SH640-CAT	-	6.35	6.85				M005	SH640FR	-	-	
SH680-CAT	-	6.75	7.25				M006	SH680FR	-	-	
SH720-CAT	-	7.15	7.65				M005	SH720FR	-	-	
SH760-CAT	-	7.55	8.05	R005	-		M006	SH760FR	-	-	
SH800-CAT	SB800-CAT	7.95	8.55				M007	SH800FR	SB800FR	-	
SH850-CAT	SB850-CAT	8.45	9.05	R006	B006	M008	SH850FR	SB850FR	-		
SH900-CAT	SB900-CAT	8.95	9.55			M007	SH900FR	SB900FR	-		
SH950-CAT	SB950-CAT	9.45	10.05	R007	B007	M008	SH950FR	SB950FR	-		
SH1000-CAT	SB1000-CAT	9.95	10.55			M009	SH1000FR	SB1000FR	-		
SH1050-CAT	SB1050-CAT	10.45	11.05			M008	SH1050FR	SB1050FR	-		
SH1100-CAT	SB1100-CAT	10.95	11.55	R008	B008	M009	SH1100FR	SB1100FR	-		
SH1150-CAT	SB1150-CAT	11.45	12.05			M010	SH1150FR	SB1150FR	-		
SH1200-CAT	SB1200-CAT	11.95	12.55	R009	B009	M009	SH1200FR	SB1200FR	-		
SH1250-CAT	SB1250-CAT	12.45	13.05			M010	SH1250FR	SB1250FR	-		
SH1300-CAT	SB1300-CAT	12.95	13.55			M011	SH1300FR	SB1300FR	-		
SH1350-CAT	SB1350-CAT	13.45	14.05			M010	SH1350FR	SB1350FR	-		
SH1400-CAT	SB1400-CAT	13.95	14.55	R010	B010	M011	SH1400FR	SB1400FR	-		
SH1450-CAT	SB1450-CAT	14.45	15.05			M012	SH1450FR	SB1450FR	-		

Specifying Tool model

SH ○○○○ - CAT E.g.: SH450-CAT

Model indicating Superroll MAC Type.

Tool model No. = Hole size x 100

SH: For through hole / SB: For blind hole

Non-burnishing length

SH-MAC (For through hole)

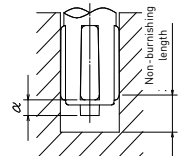

Hole size (mm)	Non-burnishing length (mm)
4.5 - 7.6	2.1 + α

SB-MAC (For blind hole)

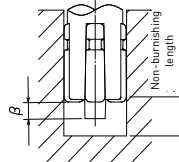

Roller	Hole size (mm)	Non-burnishing length (mm)
Standard	8 - 14.5	1.5 + β
R0.3	15 - 44	1.8 + β
R0.3	All sizes	0.8 + β

α = Tool diameter range of hole size to track [Max. 0.2 mm] x 16 - 1 mm
 * If α is a negative value, then $\alpha = 0$.

β = Tool diameter range of hole size to track [Max. 0.2 mm] x 16

E.g.: If dimensional tolerance before Superroll burnishing is ± 0.1
 → Tool diameter range to track = 0.2 mm
 Therefore, $\alpha = 0.2 \text{ mm} \times 16 - 1 = 2.2 \text{ mm}$

Hole size $\phi 15 - \phi 24$

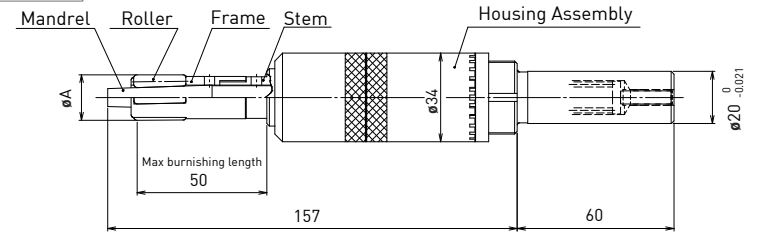

Tool model		Tool diameter adjustment range ΦA		Part No.							
Through-hole	Blind-hole	Min.	Max.	Roller		Q'ty	Mandrel	Frame		Stem	
				Through-hole	Blind-hole			Through-hole	Blind-hole		
SH1500-CAT	SB1500-CAT	14.9	16.1	R011	B011	4	M013	SH1500FR	SB1500FR	E1	
SH1600-CAT	SB1600-CAT	15.9	17.1					M014	SH1600FR	SB1600FR	E2
SH1700-CAT	SB1700-CAT	16.9	18.1	R012	B012			M015	SH1700FR	SB1700FR	E3
SH1800-CAT	SB1800-CAT	17.9	19.1					M014	SH1800FR	SB1800FR	E2
SH1900-CAT	SB1900-CAT	18.9	20.1	R011	B011			M015	SH1900FR	SB1900FR	E3
SH2000-CAT	SB2000-CAT	19.9	21.1					M016	SH2000FR	SB2000FR	E4
SH2100-CAT	SB2100-CAT	20.9	22.1			M017	SH2100FR	SB2100FR	E5		
SH2200-CAT	SB2200-CAT	21.9	23.1			M018	SH2200FR	SB2200FR	E6		
SH2300-CAT	SB2300-CAT	22.9	24.1	R012	B012	6	M017	SH2300FR	SB2300FR	E5	
SH2400-CAT	SB2400-CAT	23.9	25.1				M018	SH2400FR	SB2400FR	E6	

Hole size $\phi 25 - \phi 34$

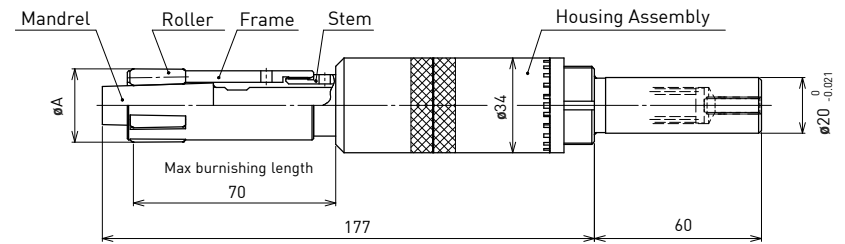

Tool model		Tool diameter adjustment range ΦA		Part No.							
Through-hole	Blind-hole	Min.	Max.	Roller		Q'ty	Mandrel	Frame		Stem	
				Through-hole	Blind-hole			Through-hole	Blind-hole		
SH2500-CAT	SB2500-CAT	24.9	26.1	R012	B012	6	M019	SH2500FR	SB2500FR	E7	
SH2600-CAT	SB2600-CAT	25.9	27.1					M020	SH2600FR		SB2600FR
SH2700-CAT	SB2700-CAT	26.9	28.1					M021	SH2700FR		SB2700FR
SH2800-CAT	SB2800-CAT	27.9	29.1					M022	SH2800FR		SB2800FR
SH2900-CAT	SB2900-CAT	28.9	30.1					M023	SH2900FR		SB2900FR
SH3000-CAT	SB3000-CAT	29.9	31.1					R013	B013		M022
SH3100-CAT	SB3100-CAT	30.9	32.1	M023	SH3100FR					SB3100FR	
SH3200-CAT	SB3200-CAT	31.9	33.1	M024	SH3200FR					SB3200FR	
SH3300-CAT	SB3300-CAT	32.9	34.1	M025	SH3300FR					SB3300FR	
SH3400-CAT	SB3400-CAT	33.9	35.1	M026	SH3400FR					SB3400FR	

Superroll MAC Selection Chart

Dimensional Drawing (mm)

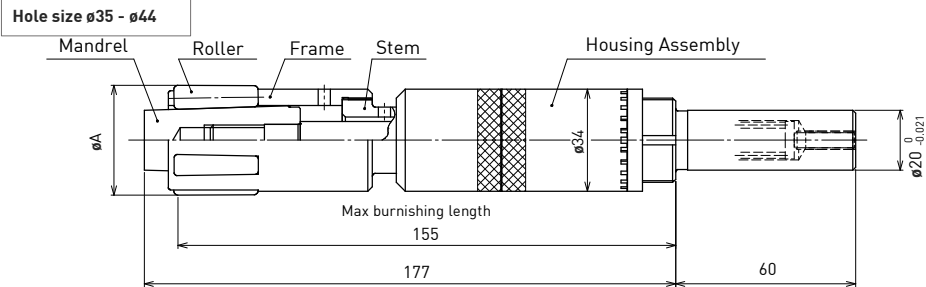

Tool model		Tool diameter adjustment range		Part No.						
Through-hole	Blind-hole	Min.	Max.	Roller			Mandrel	Frame		Stem
				Through-hole	Blind-hole	Qty		Through-hole	Blind-hole	
SH3500-CAT	SB3500-CAT	34.9	36.1	R014	B014	6	M027	SH3500FR	SB3500FR	E9
SH3600-CAT	SB3600-CAT	35.9	37.1				M028	SH3600FR	SB3600FR	
SH3700-CAT	SB3700-CAT	36.9	38.1				M029	SH3700FR	SB3700FR	
SH3800-CAT	SB3800-CAT	37.9	39.1				M030	SH3800FR	SB3800FR	
SH3900-CAT	SB3900-CAT	38.9	40.1				M031	SH3900FR	SB3900FR	
SH4000-CAT	SB4000-CAT	39.9	41.1				M030	SH4000FR	SB4000FR	
SH4100-CAT	SB4100-CAT	40.9	42.1	R015	B015	M031	SH4100FR	SB4100FR	E10	
SH4200-CAT	SB4200-CAT	41.9	43.1			M032	SH4200FR	SB4200FR		
SH4300-CAT	SB4300-CAT	42.9	44.1			M033	SH4300FR	SB4300FR		
SH4400-CAT	SB4400-CAT	43.9	45.1			M034	SH4400FR	SB4400FR		

How to use Superroll MAC

- Set a tool diameter approximately 0.05 mm bigger than an expected maximum hole size.
- Set the Pre-load.
- Conduct a trial burnishing and adjust the optimum load while checking the finished condition.

Burnishing conditions (Reference)

Hole size (mm)	Rotation speed (min ⁻¹)	Feed rate (mm/rev)	Pre-load	
			Steel	Aluminum
(N)				
4.5 - 7.6	900 - 1,800	0.1 - 0.3	10 - 60	3 - 30
8 - 14.5	800 - 1,200	0.1 - 0.4	20 - 85	4 - 40
15 - 19	700 - 1,000	0.2 - 0.5	35 - 210	7 - 70
20 - 24	600 - 800	0.3 - 0.6	60 - 360	12 - 120
25 - 34	500 - 700	0.3 - 1.0	80 - 480	16 - 160
35 - 44	400 - 600	0.3 - 1.0	90 - 540	20 - 200

* Burnishing conditions are reference only, and do not guarantee that they will achieve the customers' required values.
 * Actual burnishing conditions vary depending on the material and conditions before burnishing, so these values should be used as a reference.

About the tool weight (Reference only)

Tool model	Weight (kg)
SH(SB)450 - 1450-CAT	350 - 600
SH(SB)1500 - 2400-CAT	700 - 800
SH(SB)2500 - 3400-CAT	850 - 1,000
SH(SB)3500 - 4400-CAT	1,050 - 1,250

- *Please check the allowable tool weight for your driving machine before using the tool.
- *Please contact us if a specific tool weight is required.

About cutting mandrel tip

If the mandrel protruded length from the roller tip interferes with the bottom surface of the workpiece, cut the protruded length of the mandrel by grinding for following procedure or other means before using.

[Procedure]

- Set the required tool diameter.
- Measure the length from the roller tip to the mandrel tip with using a vernier caliper.
- Disassemble the mandrel from the main unit.
- Cut off the mandrel tip section, leaving β section from the roller tip indicated in the image on the right.
- After cutting the tip, remove burrs from the cut section and assemble the mandrel to the main unit.

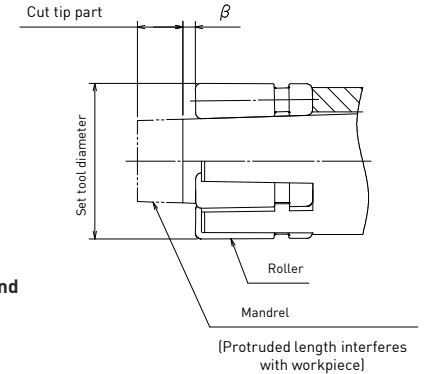

β = Tool diameter range to track (Max. 0.2 mm) x 16

[Precautions]

- Take care not to grind too much away when cutting the mandrel tip.
- The mandrel has been heat treated. To prevent a reduction in hardness due to generated heat, cut the mandrel tip while maintaining cooling.
- The mandrel is a heat treated part, so cut the tip by grinding it.